

Signature

Date

RevNo Revision note

| Itemref                 | Quantity   | Title/Name, designation, material, dimension etc | Article No /Reference |
|-------------------------|------------|--|-----------------------|
| Designed by<br>T. Isola | Checked by | Approved by - date                               | Date                  |
|                         |            | THP/SL16 - sale@JUN02                            | 1:100 (A3)            |
| THP/SL16 main dims      |            |  | Scale                 |
|                         |            |  | 1:100 (A3)            |
|                         |            |  | Edition               |
|                         |            |  | 0                     |
|                         |            |  | Sheet                 |
|                         |            |  | 1/1                   |

|       |               |      |           |         |
|-------|---------------|------|-----------|---------|
| RevNo | Revision note | Date | Signature | Checked |
| 5     |               |      |           |         |
| 6     |               |      |           |         |
| 7     |               |      |           |         |
| 8     |               |      |           |         |

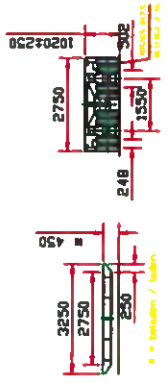
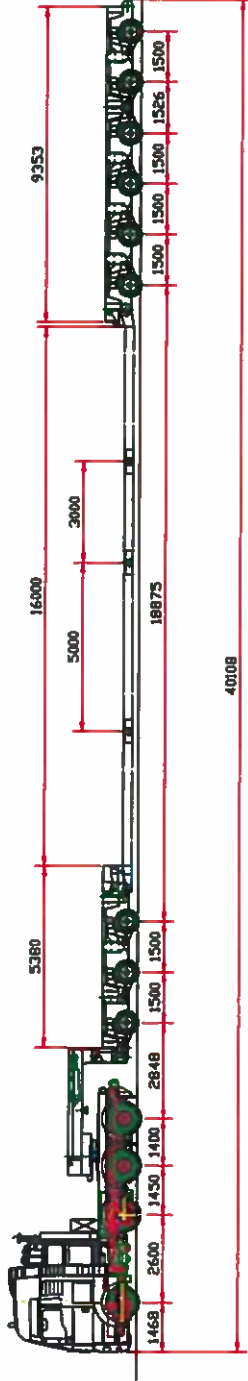

|   |            |  |                       |
|---|------------|--|-----------------------|
| Itemref   | Quantity   | Title/Name, designation, material, dimension etc | Article No./Reference |
| Designed by   | Checked by | Approved by - date                               | Date                  |
|   |            | File name  | Scale<br>1:200 (A4)   |
|  |            |  | TR207 + TC114         |
|   |            |  | Sheet<br>1/1          |

|       |               |      |           |         |
|-------|---------------|------|-----------|---------|
| RevNo | Revision note | Date | Signature | Checked |
| 5     |               |      |           |         |
| 6     |               |      |           |         |
| 7     |               |      |           |         |
| 8     |               |      |           |         |

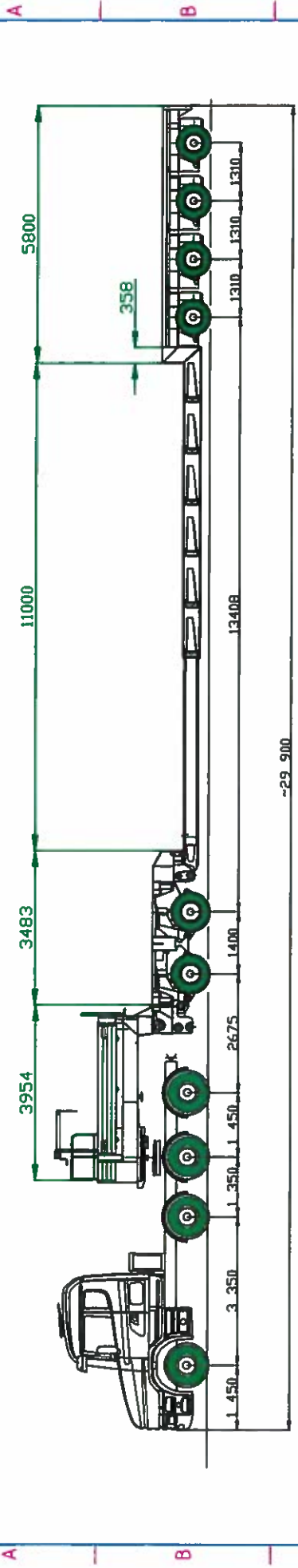

-29 900

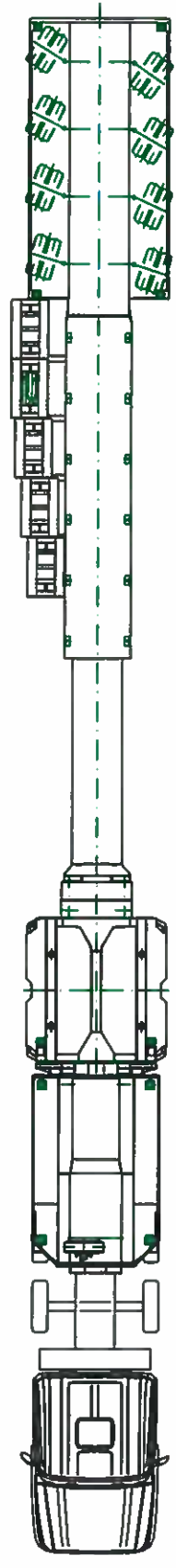

- ① Trailer position, upper
- ② Trailer position, lower

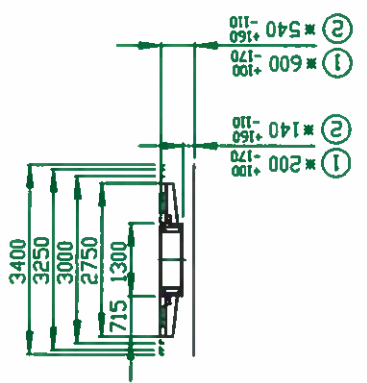
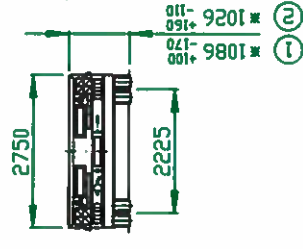
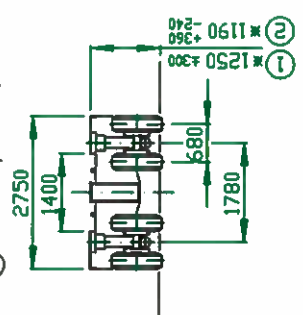

|   |            |  |                       |       |
|---|------------|--|-----------------------|-------|
| Itemref   | Quantity   | Title/Name, designation, material, dimension etc | Article No./Reference |       |
|   |            |  | File name             | Date  |
| Designed by   | Checked by | Approved by - date                               | Scale                 | Sheet |
|   |            |  | 1:100 (A4)            | 1/1   |
|  |            |  | TR213 + TC128         |       |

|       |               |      |           |         |
|-------|---------------|------|-----------|---------|
| RevNo | Revision note | Date | Signature | Checked |
| 5     |               |      |           |         |
| 6     |               |      |           |         |
| 7     |               |      |           |         |
| 8     |               |      |           |         |

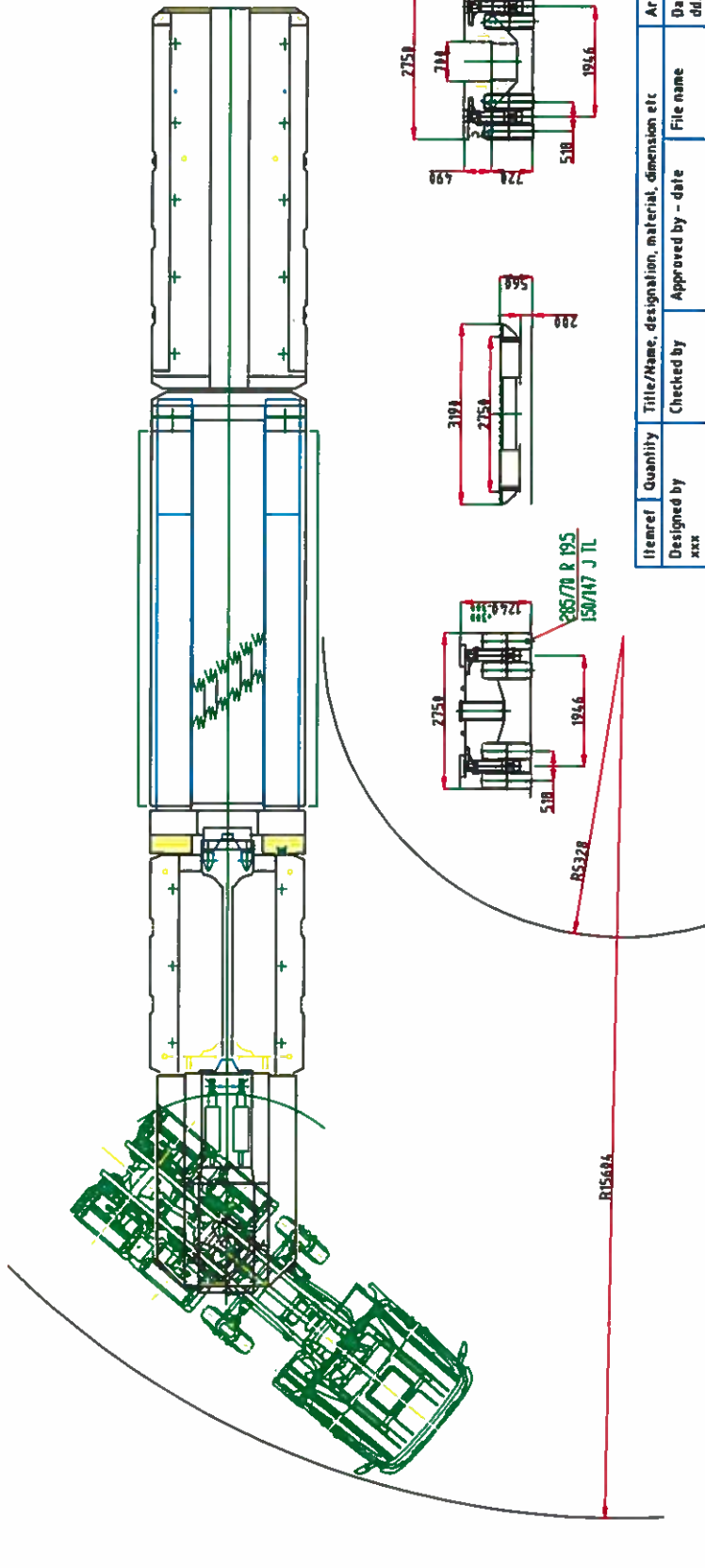
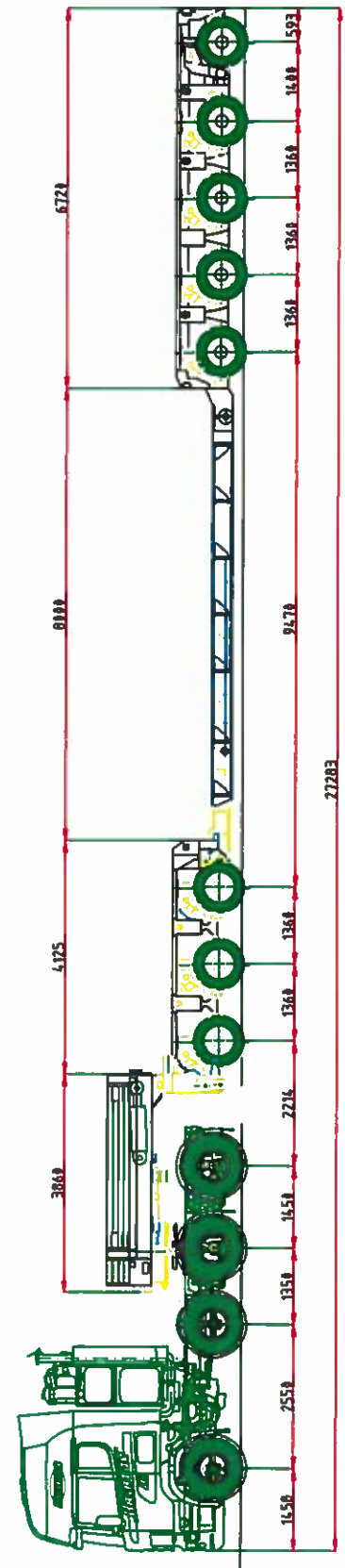

|                    |            |  |                       |
|--------------------|------------|--|-----------------------|
| Itemref            | Quantity   | Title/Name, designation, material, dimension etc | Article No./Reference |
| Designed by<br>xxx | Checked by | Approved by - date                               | Date<br>dd/mm/yy      |
| File name          |            | Scale<br>1:150 (A4)                              |                       |
| TR216 + TC129      |            | Edition<br>0                                     |                       |
| 1/1                |            | Sheet<br>1/1                                     |                       |

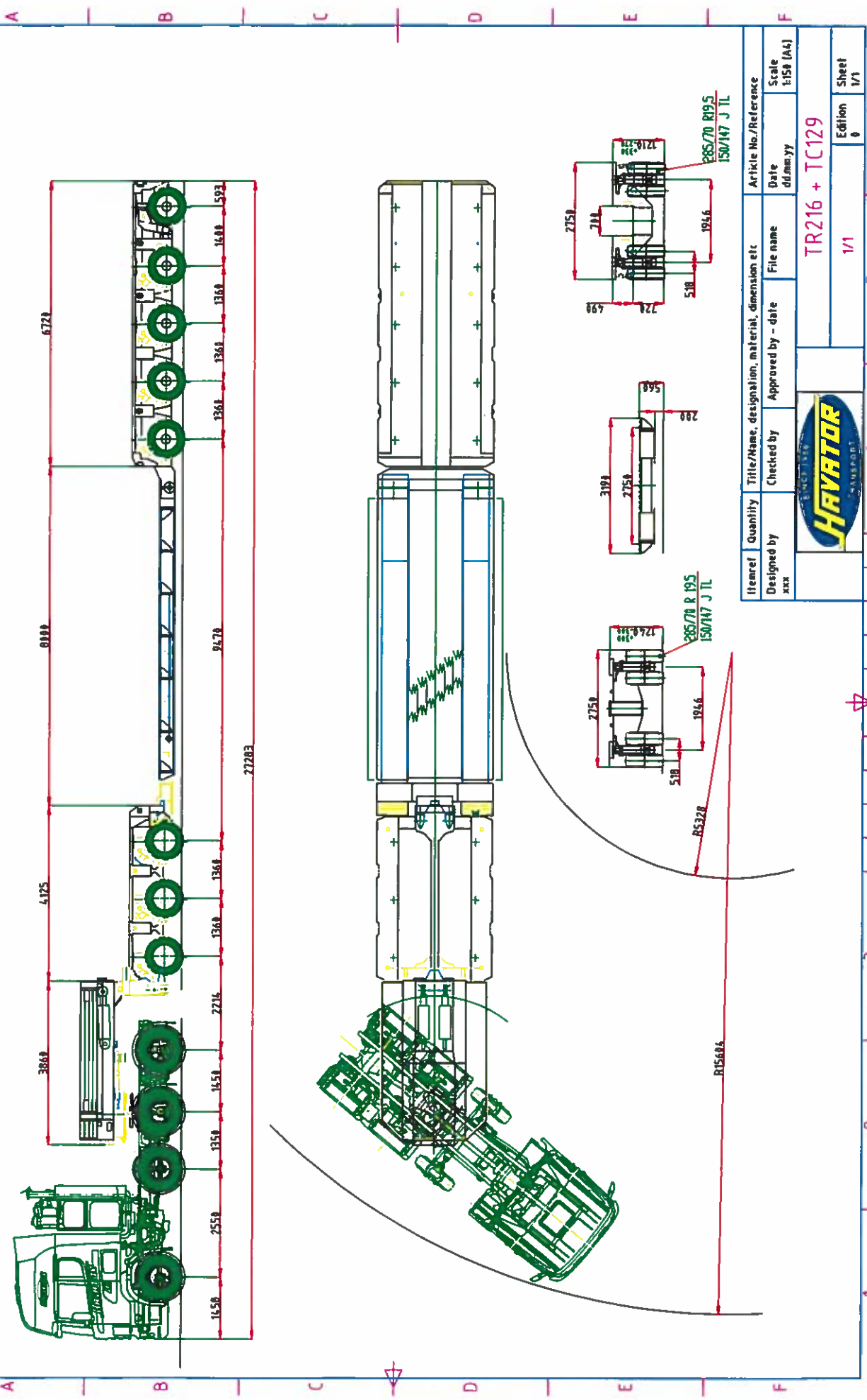

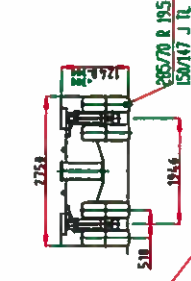
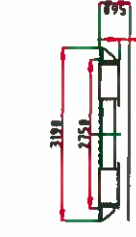
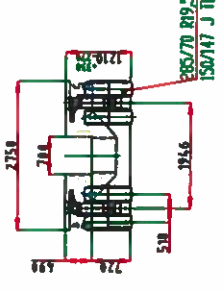
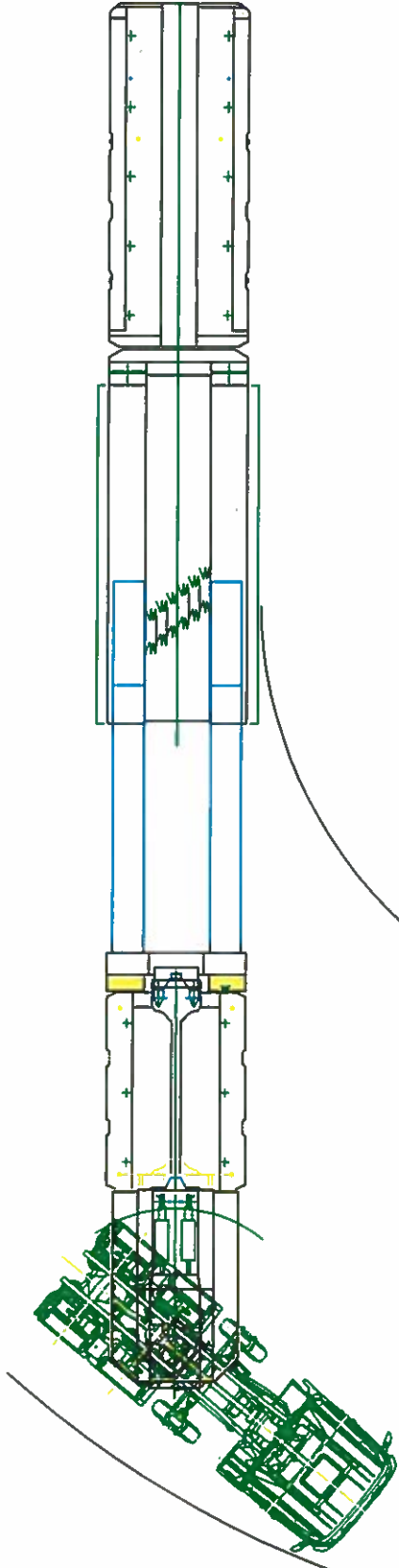
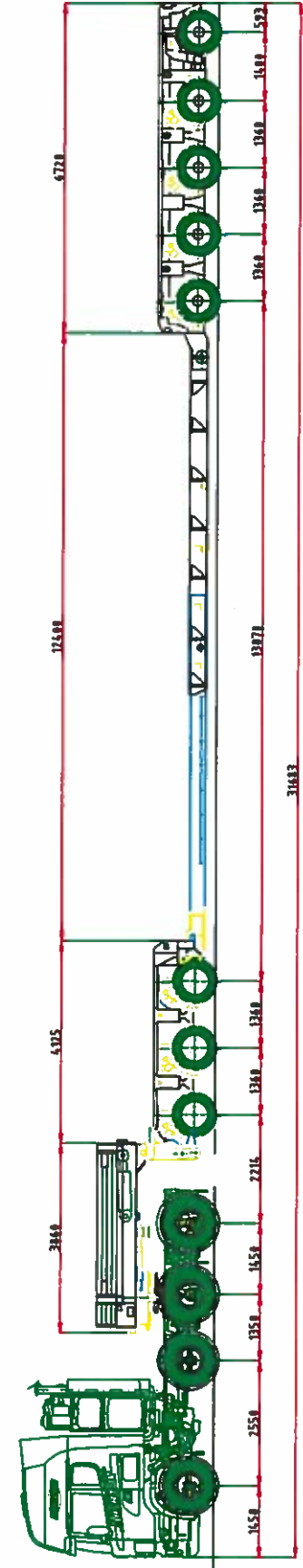

|       |   |   |   |   |               |   |      |           |
|-------|---|---|---|---|---------------|---|------|-----------|
| 1     | 2 | 3 | 4 | 5 | 6             | 7 | 8    |           |
| RevNo |   |   |   |   | Revision note |   | Date | Signature |
|       |   |   |   |   |               |   |      | Checked   |



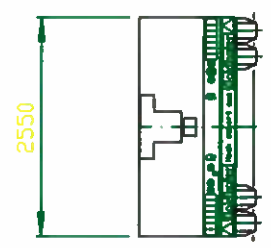
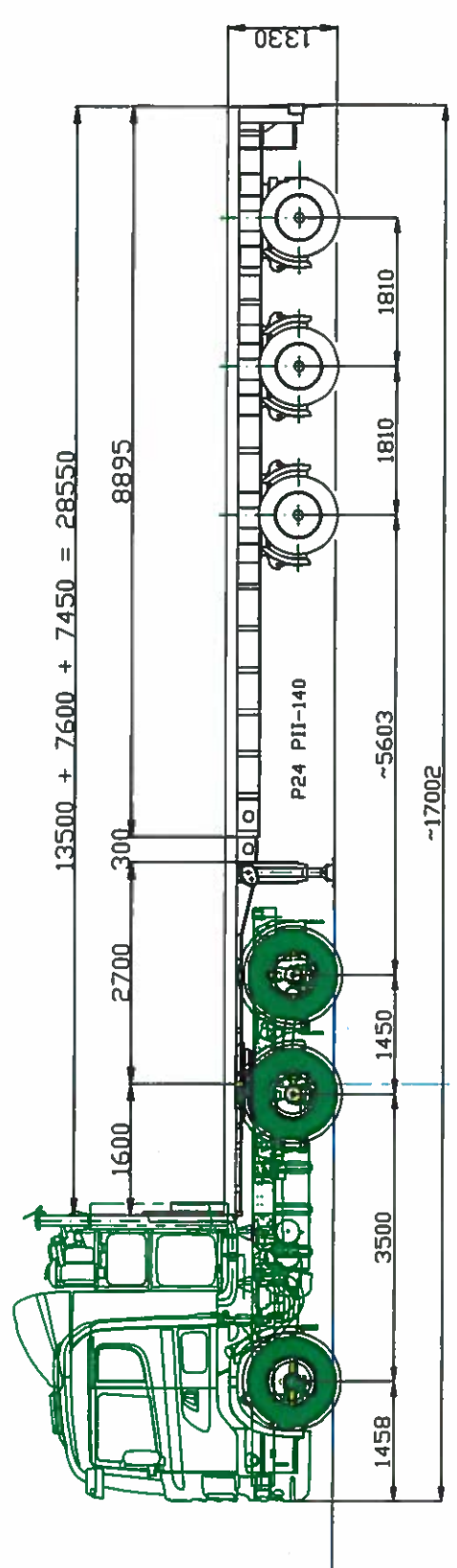

|                     |            |  |                       |
|---------------------|------------|--|-----------------------|
| Itemref             | Quantity   | Title/Name, designation, material, dimension etc | Article No./Reference |
| Designed by<br>xxx  | Checked by | Approved by - date                               | Date<br>dd.mm.yy      |
| Scale<br>1:150 (A4) |            | File name<br>TR216 + TC129                       |                       |
| Edition<br>0        |            | Sheet<br>1/1                                     |                       |



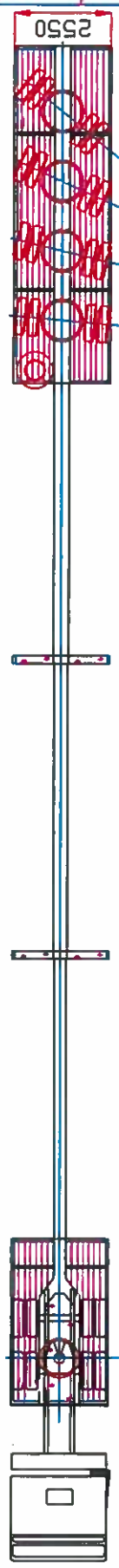
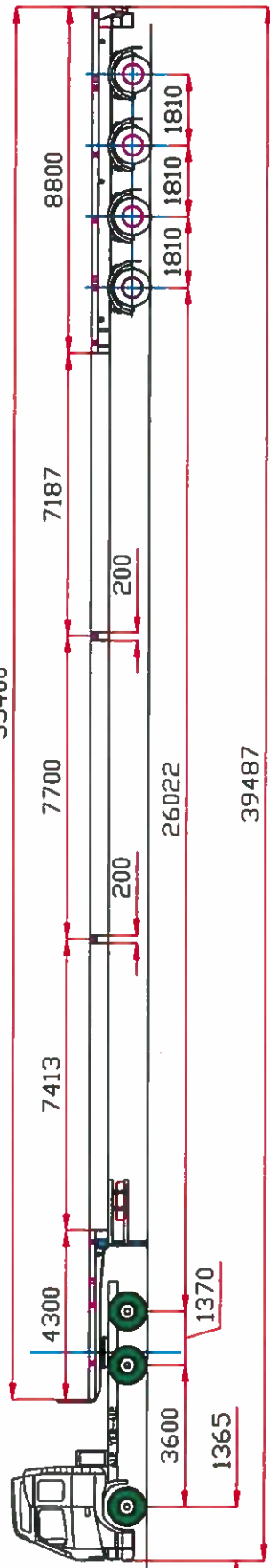

|   |            |  |                       |
|---|------------|--|-----------------------|
| Itemref   | Quantity   | Title/Name, designation, material, dimension etc | Article No./Reference |
| Designed by<br>xxx  | Checked by | Approved by - date                               | Date<br>dd.mm.yy      |
|   |            | File name  | Scale<br>E:100 (A4)   |
|  |            | TR224 + TC102                                    |                       |
|   |            | Edition<br>6                                     | Sheet<br>1/1          |



|   |            |  |                       |
|---|------------|--|-----------------------|
| Itemref   | Quantity   | Title/Name, designation, material, dimension etc | Article No./Reference |
| Designed by   | Checked by | Approved by - date                               | Date                  |
|   |            |  | Scale<br>1:150(A4)    |
|  |            |  | TR240 + TC112         |
|   |            |  | Sheet<br>1/1          |